

SITE SPECIFIC DATA			
PROJECT NUMBER			
ORDER NUMBER			
PROJECT NAME			
PROJECT LOCATION			
STRUCTURE ID			
TREATMENT REQUIRED			
VOLUME BASED (CF)		FLOW BASED (CFS)	
TREATMENT HGL AVAILABLE (FT)			
PEAK BYPASS REQUIRED (CFS) – IF APPLICABLE			
PIPE DATA	I.E.	MATERIAL	DIAMETER
INLET PIPE 1			
INLET PIPE 2			
OUTLET PIPE			
	PRETREATMENT	BIOFILTRATION	DISCHARGE
RIM ELEVATION			
SURFACE LOAD	PEDESTRIAN	OPEN PLANTER	PEDESTRIAN
FRAME & COVER	36" X 36"	N/A	N/A
WETLANDMEDIA VOLUME (CY)		TBD	
ORIFICE SIZE (DIA. INCHES)		TBD	
NOTES: PRELIMINARY NOT FOR CONSTRUCTION.			

INSTALLATION NOTES

- CONTRACTOR TO PROVIDE ALL LABOR, EQUIPMENT, MATERIALS AND INCIDENTALS REQUIRED TO OFFLOAD AND INSTALL THE SYSTEM AND APPURTENANCES IN ACCORDANCE WITH THIS DRAWING AND THE MANUFACTURERS SPECIFICATIONS, UNLESS OTHERWISE STATED IN MANUFACTURERS CONTRACT.
- UNIT MUST BE INSTALLED ON LEVEL BASE. MANUFACTURER RECOMMENDS A MINIMUM 6" LEVEL ROCK BASE UNLESS SPECIFIED BY THE PROJECT ENGINEER. CONTRACTOR IS RESPONSIBLE TO VERIFY PROJECT ENGINEERS RECOMMENDED BASE SPECIFICATIONS.
- CONTRACTOR TO SUPPLY AND INSTALL ALL EXTERNAL CONNECTING PIPES. ALL PIPES MUST BE FLUSH WITH INSIDE SURFACE OF CONCRETE. (PIPES CANNOT INTRUDE BEYOND FLUSH). INVERT OF OUTFLOW PIPE MUST BE FLUSH WITH DISCHARGE CHAMBER FLOOR. ALL PIPES SHALL BE SEALED WATER TIGHT PER MANUFACTURERS STANDARD CONNECTION DETAIL.
- CONTRACTOR RESPONSIBLE FOR INSTALLATION OF ALL RISERS, MANHOLES, AND HATCHES. CONTRACTOR TO GROUT ALL MANHOLES AND HATCHES TO MATCH FINISHED SURFACE UNLESS SPECIFIED OTHERWISE.
- VEGETATION SUPPLIED AND INSTALLED BY OTHERS. ALL UNITS WITH VEGETATION MUST HAVE DRIP OR SPRAY IRRIGATION SUPPLIED AND INSTALLED BY OTHERS.
- CONTRACTOR RESPONSIBLE FOR CONTACTING BIO CLEAN FOR ACTIVATION OF UNIT. MANUFACTURERS WARRANTY IS VOID WITH OUT PROPER ACTIVATION BY A BIO CLEAN REPRESENTATIVE.

GENERAL NOTES

- MANUFACTURER TO PROVIDE ALL MATERIALS UNLESS OTHERWISE NOTED.
- ALL DIMENSIONS, ELEVATIONS, SPECIFICATIONS AND CAPACITIES ARE SUBJECT TO CHANGE. FOR PROJECT SPECIFIC DRAWINGS DETAILING EXACT DIMENSIONS, WEIGHTS AND ACCESSORIES PLEASE CONTACT BIO CLEAN.

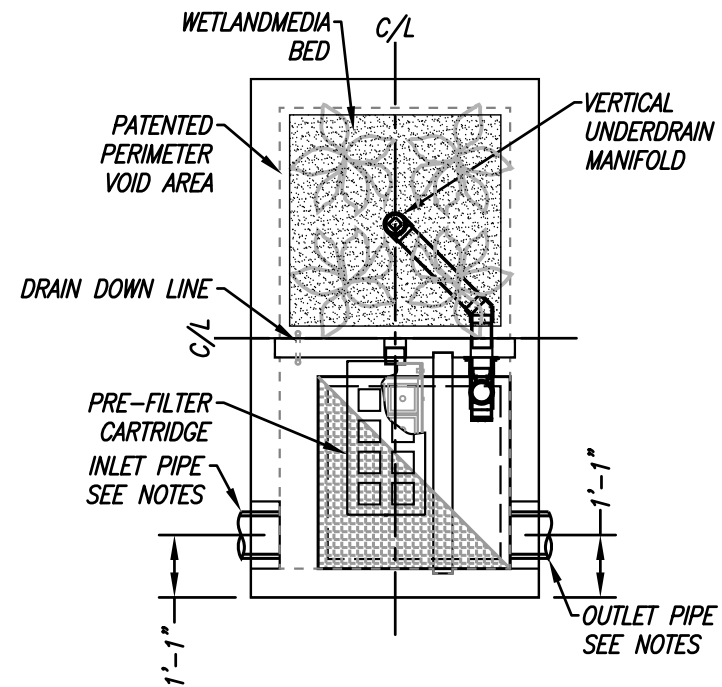

PLAN VIEW

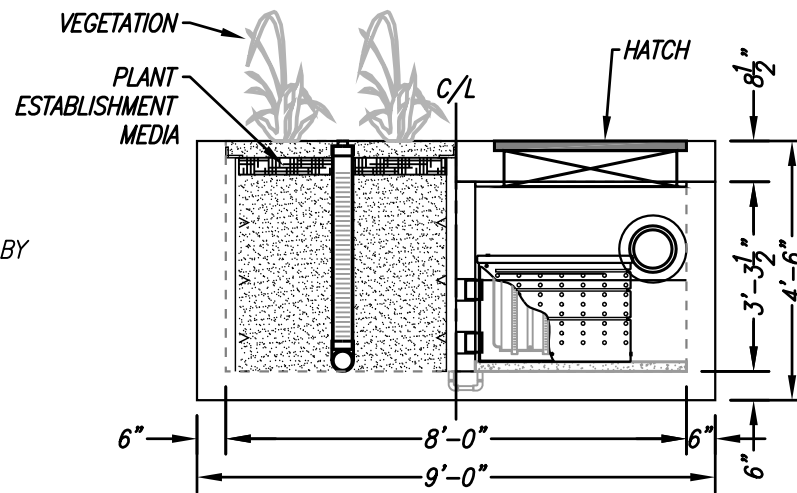

LEFT END VIEW

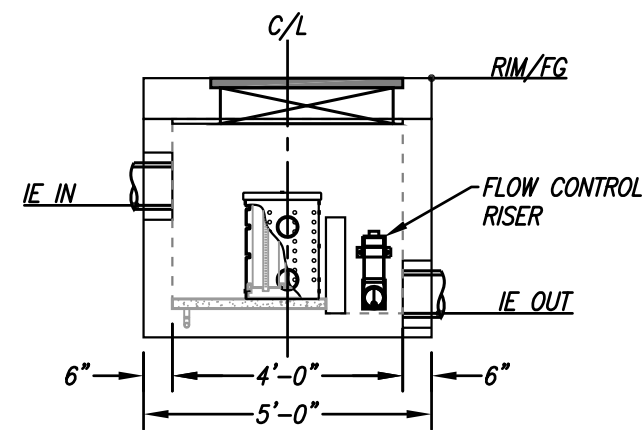

ELEVATION VIEW

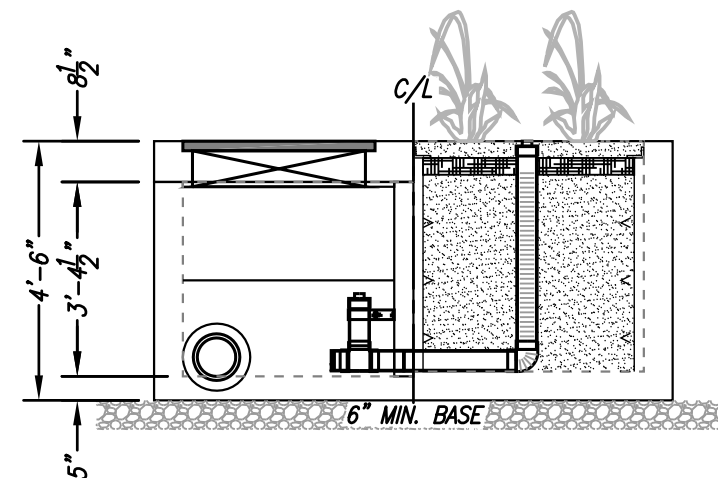

RIGHT END VIEW

TREATMENT FLOW (CFS)	0.115
OPERATING HEAD (FT)	3.4
PRETREATMENT LOADING RATE (GPM/SF)	2.0
WETLAND MEDIA LOADING RATE (GPM/SF)	1.0

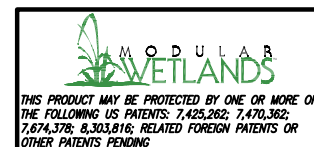

PROPRIETARY AND CONFIDENTIAL:
 THE INFORMATION CONTAINED IN THIS DOCUMENT IS THE SOLE PROPERTY OF FORTERRA AND ITS COMPANIES. THIS DOCUMENT, NOR ANY PART THEREOF, MAY BE USED, REPRODUCED OR MODIFIED IN ANY MANNER WITH OUT THE WRITTEN CONSENT OF FORTERRA.



MWS-L-4-8-V
STORMWATER BIOFILTRATION SYSTEM
STANDARD DETAIL